

Hoz es il Di da las inventedras  
e dals inventeders

la rouda

il telefonin

il trampolin

l'avium



**NOVEMBER**

 Schweizerische Eidgenossenschaft  
Confédération suisse  
Confederazione Svizzera  
Confederaziun svizra

text: Charitina Josty, illustraziun: Yvonne Giènel,  
grafica: Theres Jäger  
© Lia Rumantscha

**KIDSFITSC**  
Lia Rumantscha

# Il Di da las inventedras e dals inventeders

Chi ho insè invento ils ogets cha nus druvains mincha di? Chi ho invento il telefonin, il pairin eletric, il velo, la fras-chera, il palperi u las jeans? Bgeras da quistas robas nu sun stedas cò dad ün di a l'oter. Qualchün ho il prüm stuvieu avair l'ideja e zambrager prümas versiuns dals ogets. Quistas personas as nomna inventedras ed inventeders. Scu per exaimpel Thomas Edison chi ho fat experimaints cun forz'eletrica e chi ho güdo ad inventer il pairin eletric. El nun ho mêt do sü! Sch'el vulaiva inventer qualchosa e scha que nun ho güsta funcziuno dalum, dschaiva'l: «Que nun es üngüna sconfitta, eau d'he simplamaing chatto 10'000 möds cu cha que nu funcziuna.»

Inventedras ed inventeders sun personas cun fantasia, idejas e curaschi. Scu per exaimpel Hedy Lamarr. Ella d'eira actura a Hollywood ed inventedra. L'an 1941 ho ella lascho patenter ün'invenziun da la tecnica da funcchi'd es pü tard dvanteda la basa per noss telefonins ed il wlan. Hedy Lamarr nun ho mêt survgnieu raps per si'invenziun. Per la peja es sieu anniversari, ils 9 november, dvanto il Di da las inventedras e dals inventeders. Almain in Svizra, Austria ed in Germania. In oters pajais do que oters dis da las inventedras e dals inventeders u dis da las invenziuns, ma a vo adüna per il listess: las invenziuns ed il curaschi da las inventedras e dals inventeders dessian inspirer a nus tuots. Minchün e minchüna pudess inventer qualchosa!

Hest eir tü già invento qualchosa?  
Forsa ün gö u ün giovaret?

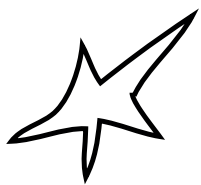

Che as stuvess inventer tenor te?

Cugnuoschast tü ad inventedras u inventeders?



Dumanda a tieus genituors u a tieu non e nona: Che invenziun ho müdo il pü ferm lur vita?



# Invenziuns interessantas e/u importantas

| invenziun                                     | inventeder/inventedra               | an                 |
|---|-------------------------------------|--------------------|
| ● la rouda                                    | incuntschaint                       | 3'500 aunz Cristus |
| ● il palperi                                  | Cai Lun                             | 105 zieva Cristus  |
| ● il velo                                     | Karl Drais                          | 1817               |
| ● la maschina per fer<br>glatsch (per manger) | Nancy Johnson                       | 1843               |
| ● il telefon                                  | Philipp Reiss                       | 1861               |
| ● il tschic                                   | Thomas Adams                        | 1870               |
| ● las jeans                                   | Levi Strauss                        | 1873               |
| ● la fras-chera                               | Carl von Linde                      | 1876               |
| ● il pair electric                            | Thomas Edison                       | 1879               |
| ● l'auto                                      | Karl Benz                           | 1885               |
| ● Coca-Cola                                   | John Stith Pemberton                | 1886               |
| ● il tschütschapuolvra                        | Hubert Cecil Booth                  | 1901               |
| ● l'uors da plüsch/teddy                      | Richard Steiff                      | 1902               |
| ● l'avion                                     | frers Wright                        | 1903               |
| ● il jojo                                     | Charles Hettrick                    | 1928               |
| ● il trampolin                                | George Nissen                       | 1936               |
| ● il prüm computer                            | Konrad Zuse                         | 1941               |
| ● LEGO  | Ole Kirk Christiansen               | 1949               |
| ● il pez per druver<br>üna vouta              | Marion Donovan                      | 1950               |
| ● la cella solara                             | G. Pearson, D. Chapin,<br>C. Fuller | 1954               |
| ● il rinch da hula-hoop                       | Richard Knerr<br>ed Arthur Melin    | 1958               |
| ● l'e-mail                                    | Ray Tomlinson                       | 1971               |
| ● il telefonin                                | Martin Cooper                       | 1973               |
| ● WiFi  | Vic Hayes                           | 1997               |
| ● il smartphone                               | differentas firmas,<br>p. ex. Apple | 2007               |

# Invenziuns svizras

| invenziun                                   | inventeder/inventedra               | an                |
|---|-------------------------------------|-------------------|
| ● la Crusch Cotschna                        | Henry Dunant                        | 1863              |
| ● Maggi                                     | Julius Maggi                        | 1886              |
| ● la tschiculatta da lat                    | Daniel Peter                        | 1875              |
| ● il curtè da giglioffa                     | Karl Elsener                        | 1891              |
| ● l'aspirin (medicament cunter las duluors) | Felix Hoffmann                      | 1897              |
| ● il chaschöl<br>Tête de moine              | Fritz Bichsel                       | 1899              |
| ● la buoglia da Bircher                     | Maximilian Oskar<br>Bircher-Brenner | intuorn l'an 1900 |
| ● la via da bob                             | Caspar Badrutt                      | 1904              |
| ● Ovomaltine                                | Abert Wander                        | 1904              |
| ● la folia d'aluminium                      | Heinrich Alfred Gautschi            | 1905              |
| ● il cellofan<br>(folia transparenta)       | Jacques Edwin<br>Brandenberger      | 1908              |
| ● il zip                                    | Martin O. Winterhalter              | 1923              |
| ● il runel                                  | Ernst Gustav Constam                | 1930              |
| ● Nescafé                                   | Max Morgenthaler                    | 1936              |
| ● Ricola                                    | Emil Richterich                     | 1940              |
| ● Aromat                                    | Walter Obrist                       | 1945              |
| ● il spletscheder                           | Alfred Neweczeral                   | 1947              |
| ● il schmacha-agl                           | Karl Zysset                         | ils ans 1950      |
| ● Rivella                                   | Robert Barth                        | 1950              |
| ● la vlücrötsch (morzip)                    | Georges de Mestral                  | 1951              |
| ● il mixer a bachetta                       | Roger Perrinjaquet                  | 1954              |
| ● Swatch (ura)                              | Nicolas Hayek                       | 1983              |
| ● il world wide web                         | Tim Berners-Lee<br>(CERN Geneva)    | 1990              |
| ● Doodle                                    | Michael Näf<br>e Paul E. Sevinç     | 2003              |
| ● l'aviun solar<br>(Solar Impulse II)       | Bertrand Piccard                    | 2015              |

# Invenziun: maschina d'iffaunts 1

- 1 Tuot ils iffauts faun ün rinch.
- 2 Iffaunt A vo aint il rinch e cumainza a fer ün simpel movimaint chi's repeta.
- 3 Iffaunt B vain vitiers e fo ün oter movimaint – scu ün nouv töch da la maschina.
- 4 Iffaunt C vain vitiers e fo darcho ün oter movimaint da la maschina.  
Uschè vo que inavaunt fin cha tuot ils iffauts haun «construieu» insembel üna granda maschina chi's mouva permanentamaing.

Per varier il tempo stöglan tuots s'adatter e per exaimpel fer pü svelt u pü plaun ils movimaints. Vain l'intera grupp a fer ster salda la maschina al listess mumaint?

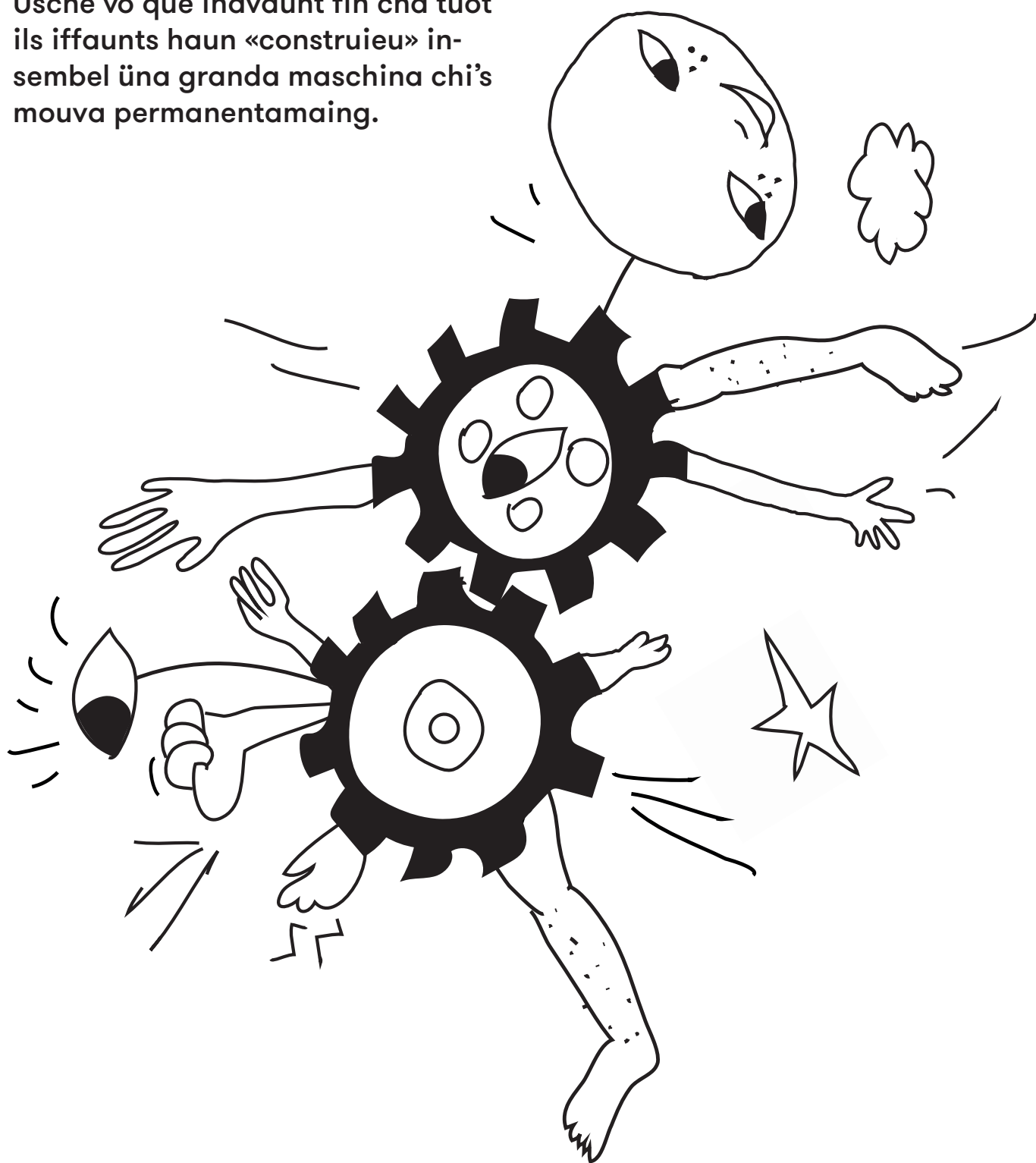

# Tia invenziun

2

Che inventessast tü? Ponderescha.  
Disegna ti'invenziun. Cu ho nom  
ti'invenziun?



# Tieu oget

3

Ramassa palperi vegl, chartun,  
butiglias da PET, cucuns da  
butiglias da vin, s-chaclas da tola,  
filfier, eui.

Zambragia qualchosa cun quist  
materiel. Invainta ün nouv oget.  
Cu guard'our ti'invenziun?

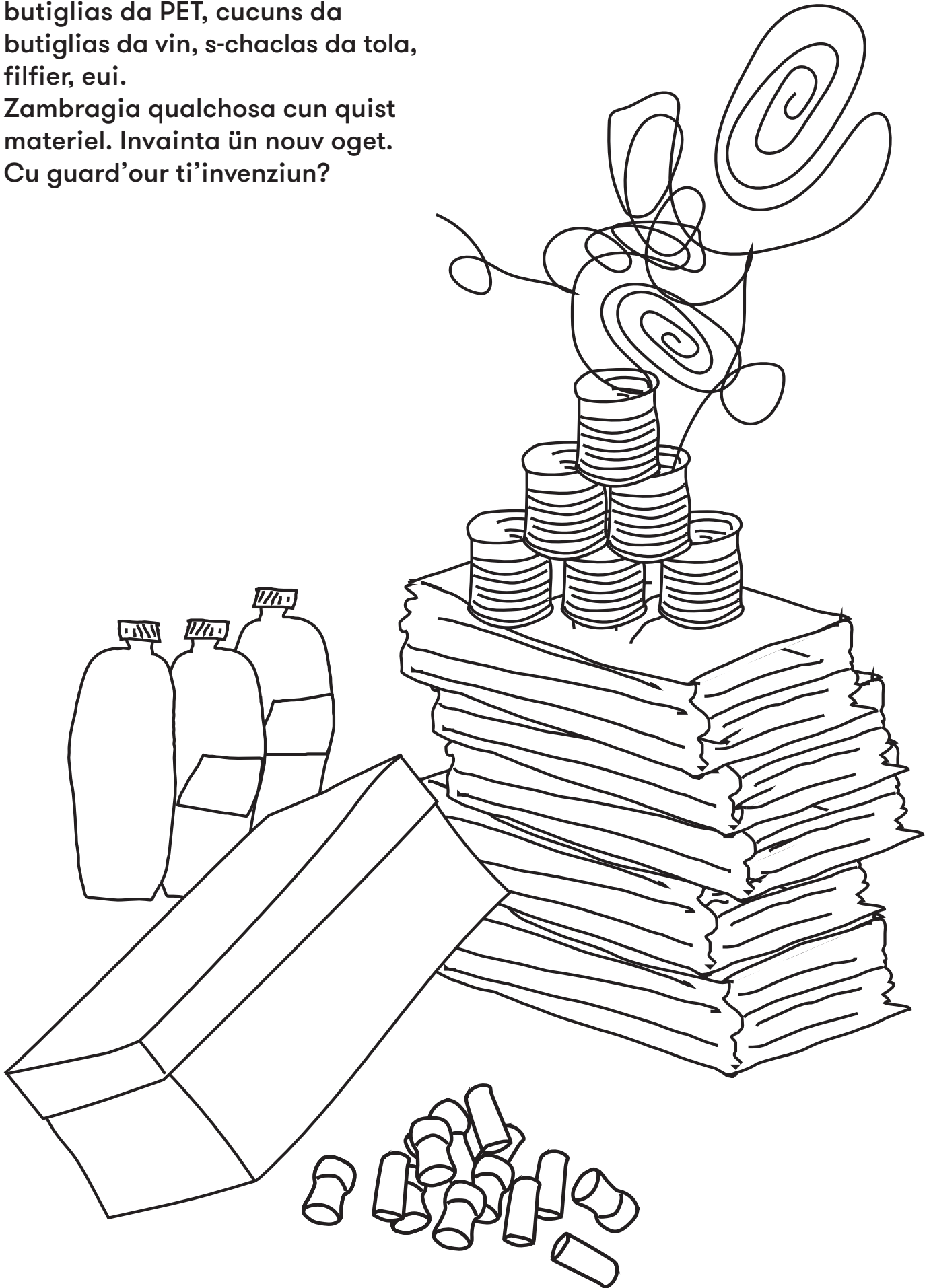

# Tieu pled

Taglia our ils plets u eir be parts  
dals plets e'ls cumbina. Cu tuna  
tieu pled invento?

# roboter<sup>4</sup>

# tschiculatta

# fras-chera

# tschütschapuolvra

# experimaint

# sfranzinella

# maschine

# sapperlot

# raketa

# telefonin

# chaschöl

# inventedra



# Tieu roboter

Taglia our ils purtrets\* e fo üna collascha. Invainta ün roboter. Cu guarda'l our e che so fer tieu roboter?

\* Ils purtrets sun our da: Schnippelbuch Nr. 2, Kultur & Spielraum e.V. München, 1999/2015, [www.schnippelbuch.de](http://www.schnippelbuch.de)

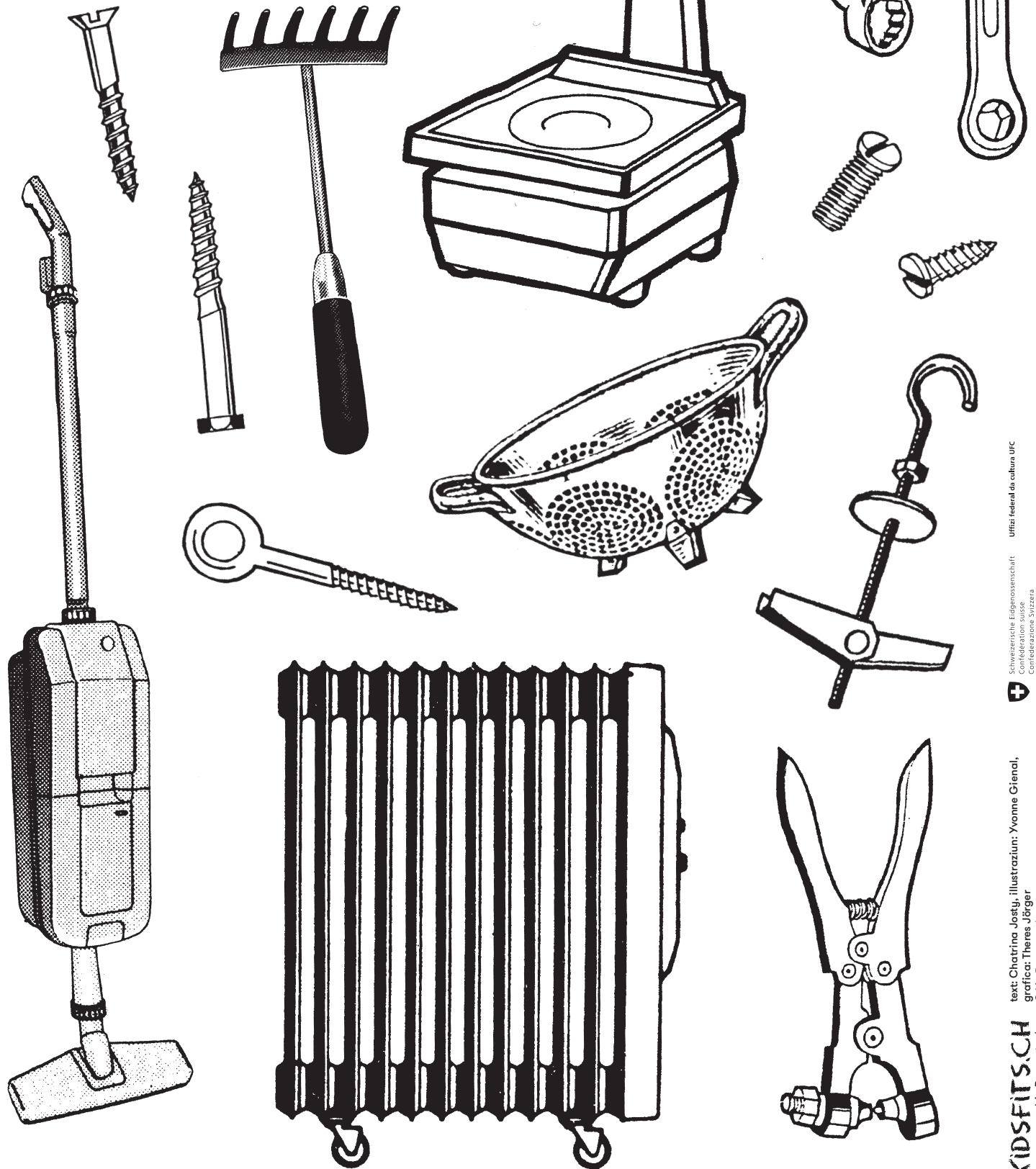

5



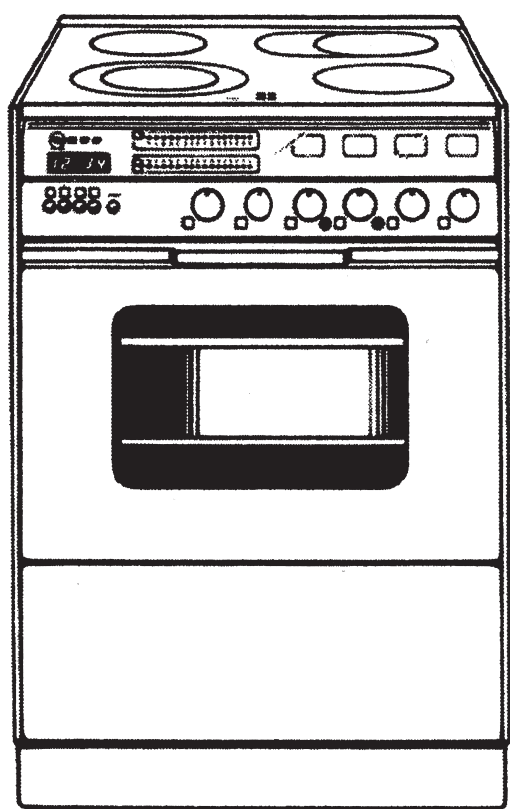
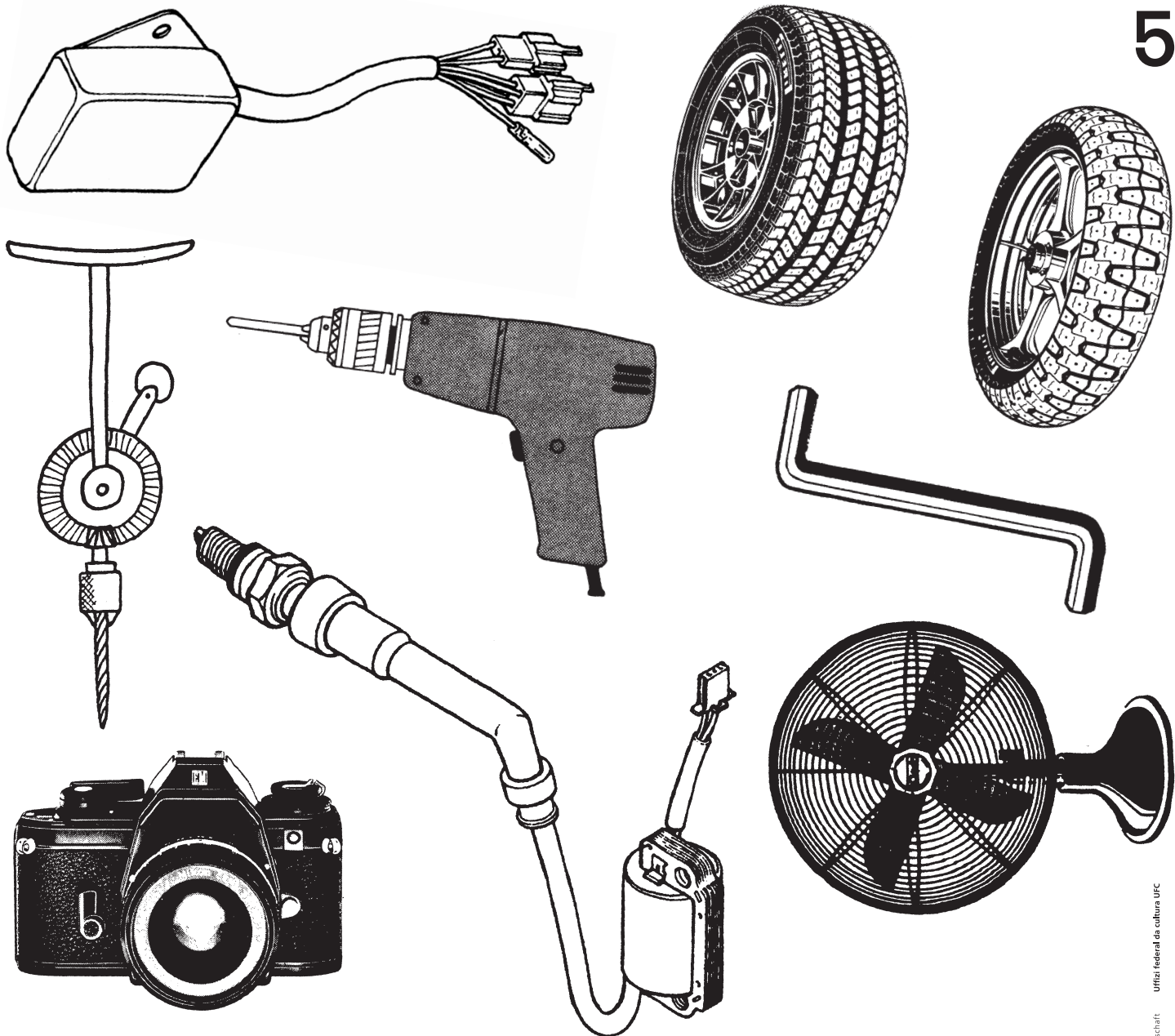

Schweizerische Eidgenossenschaft  
 Confédération suisse  
 Confederazione Svizzera  
 Confederaziun svizra  
 Ufficio federal da cultura UFC

text: Chattrina Josty, illustration: Yvonne Giènel,  
 grafica: Theres Jäger  
 © Lia Rumantscha

**KIDSFITTSCH**  
 Lia Rumantscha

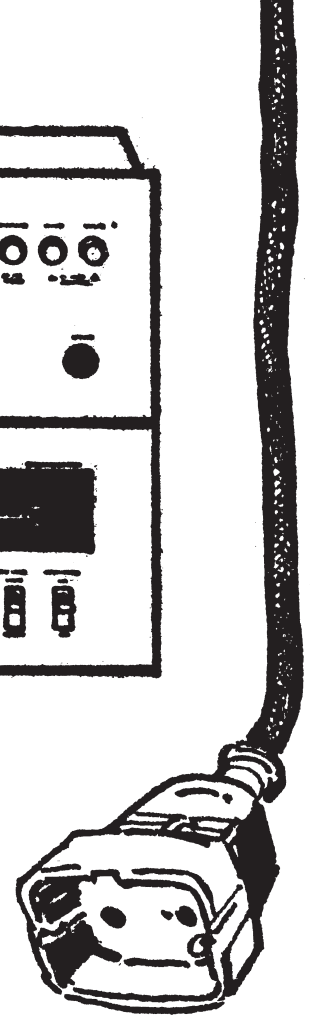
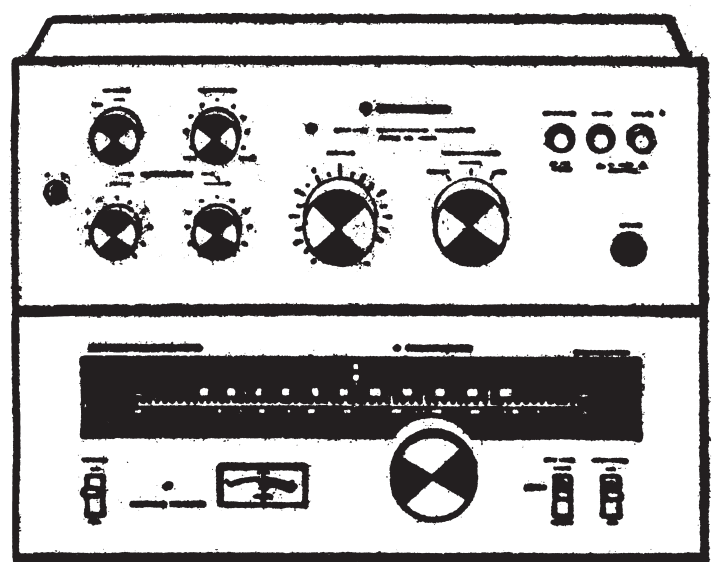
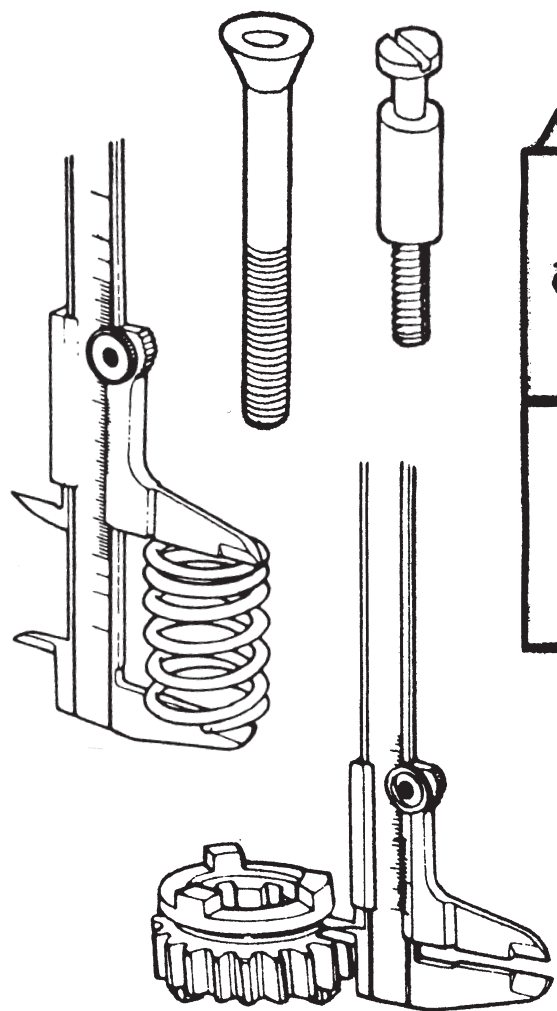
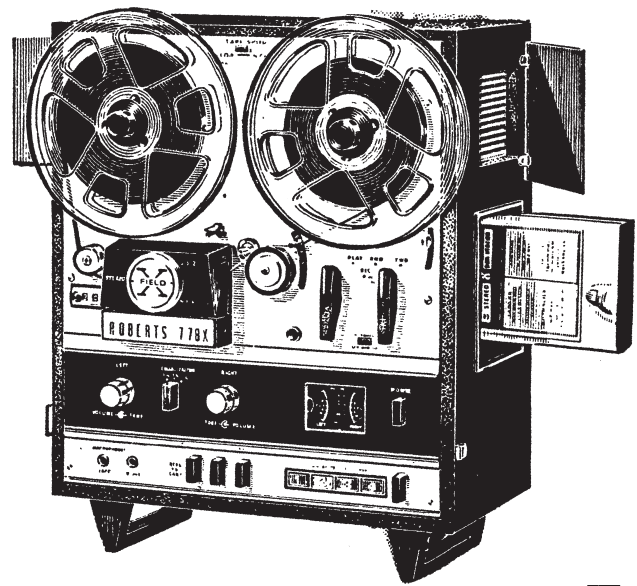
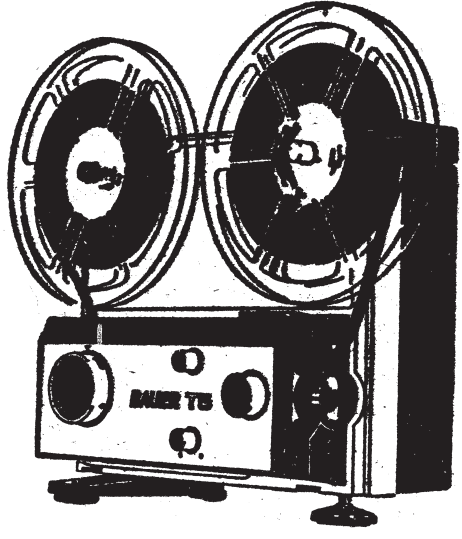
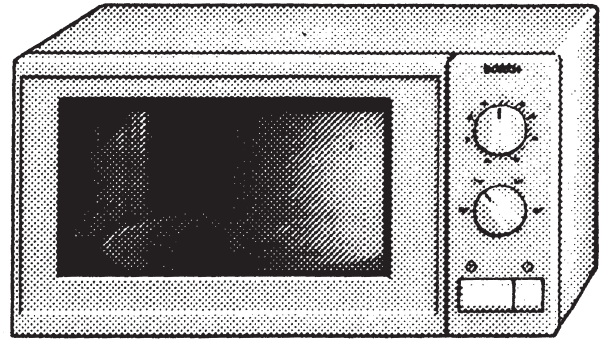
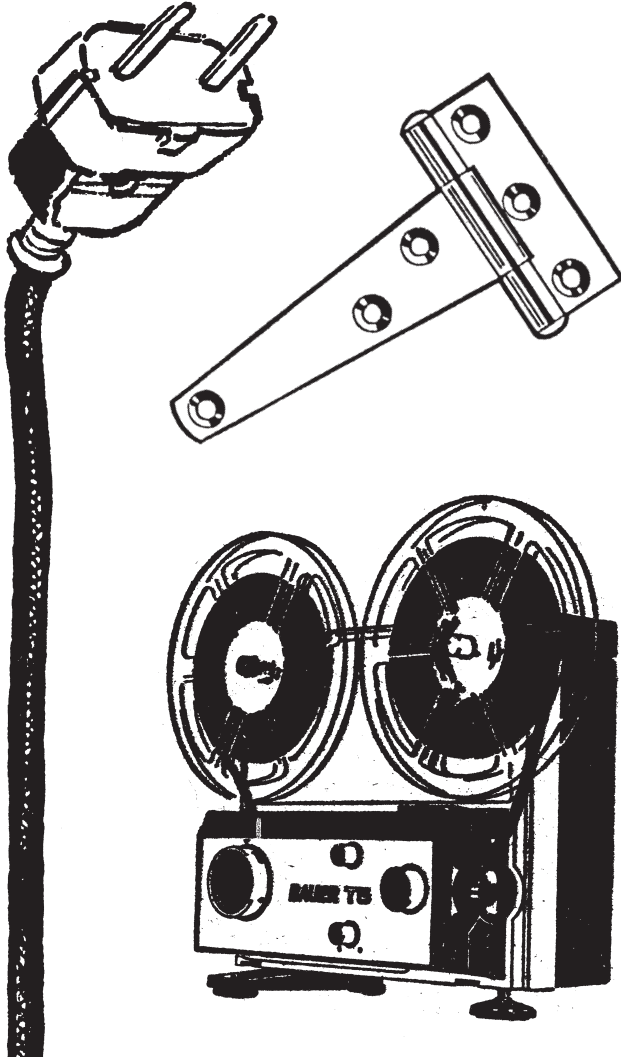

 Schweizerische Eidgenossenschaft  
 Confédération suisse  
 Confederazione Svizzera  
 Confederaziun svizra  
 Ufficio federal da cultura UFC

text: Chatrina Josty, Illustration: Yvonne Gièni,  
 grafica: Theres Jönger  
 © Lia Rumantscha

**KIDSFITSCH**  
 Lia Rumantscha