

Oz è il Di da las inventadras
e dals inventaders

la roda

il telefonin

il trampolin

l'avium



NOVEMBER

Il Di da las inventadras e dals inventaders

Tgi ha en sasez inventà las chaussas che nus duvrain mintga di? Tgi ha inventà il telefonin, il pair electric, il velo, la frestgera, il palpìri u las jeans? Bleras da questas chaussas n'èn betg stadas qua dad in di a l'auter. Insatgi ha l'emprim stuì avair l'idea e zambergiar emprimas versiuns da las chaussas. Quellas personas numn'ins inventadras ed inventaders. Sco per exempel Thomas Edison che ha fatg experiments cun forza electrica e che ha gidà ad inventar il pair electric. El n'ha mai dà si! Cura ch'el vuleva inventar insatge ed i na funcziunava betg immediat, scheva el: «Jau n'hai betg disditg, jau hai simplamain chattà 10'000 modas co ch'i na funcziuna betg.»

Inventadras ed inventaders èn persunas cun fantasia, ideas e curaschi. Sco per exempel Hedy Lamarr. Ella era actura a Hollywood ed inventadra. L'onn 1941 ha ella laschà patentar in'invenziun da la tecnica da func ch'è pli tard daventada la basa per noss telefonins ed il wlan. Hedy Lamarr n'ha mai survegnì raps per sia invenziun. Per la paja è ses di da naschientscha, ils 9 da november, daventà il Di da las inventadras e dals inventaders. Almain en Svizra, l'Austria e la Germania. En auters pajais datti auters dis da las inventadras e dals inventaders u dis da las invenziuns, ma i va per il medem: las invenziuns ed il curaschi da las inventadras e dals inventaders duain inspirar nus tuts. Mintgin e mintgina pudess inventar insatge!

*Has ti era gia inventà insatge?
Forsa in gieu u in termagl?*

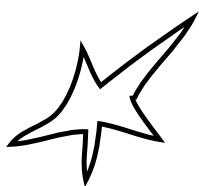

Tge stuess ins tenor tai inventar?

*Enconuschas ti inventadras
u inventaders?*

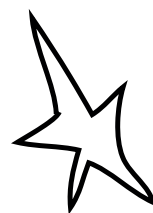

*Dumonda tes geniturs u tes tat
e tia tatta: Tge invenziun ha midà
il pli fitg lur vita?*



Invenziuns interessantas u/ed impurtantas

invenziun	inventader/inventadra	onn
● la roda	nunenconuschent	3'500 avant Cristus
● il palpiri	Cai Lun	105 suenter Cristus
● il velo	Karl Drais	1817
● la maschina da glatschs (per mangiar)	Nancy Johnson	1843
● il telefon	Philipp Reiss	1861
● il schlogn	Thomas Adams	1870
● las jeans	Levi Strauss	1873
● la frestgera	Carl von Linde	1876
● il pair electric	Thomas Edison	1879
● l'auto	Karl Benz	1885
● Coca-Cola	John Stith Pemberton	1886
● il tschitschapulvra	Hubert Cecil Booth	1901
● l'urset/il teddy	Richard Steiff	1902
● l'avion	frars Wright	1903
● il jojo	Charles Hettrick	1928
● il trampolin	George Nissen	1936
● l'emprim computer	Konrad Zuse	1941
● LEGO	Ole Kirk Christiansen	1949
● il pez per duvrar ina giada	Marion Donovan	1950
● la cella solara	G. Pearson, D. Chapin, C. Fuller	1954
● il rintg da hula-hoop	Richard Knerr ed Arthur Melin	1958
● l'e-mail	Ray Tomlinson	1971
● il telefonin	Martin Cooper	1973
● WiFi	Vic Hayes	1997
● il smartphone	differentas firmas, p. ex. Apple	2007

Invenziuns svizras

invenziun	inventader/inventadra	onn
● la Crusch Cotschna	Henry Dunant	1863
● Maggi	Julius Maggi	1886
● la tschigulatta da latg	Daniel Peter	1875
● il cuntè da satg	Karl Elsener	1891
● l'aspirin (med cunter las dolurs)	Felix Hoffmann	1897
● il chaschiel Tête de moine	Fritz Bichsel	1899
● la buglia da Bircher	Maximilian Oskar Bircher-Brenner	enturn il 1900
● il vial da bob	Caspar Badrutt	1904
● Ovomaltine	Abert Wander	1904
● la folia d'aluminium	Heinrich Alfred Gautschi	1905
● il cellofan (folia transparenta)	Jacques Edwin Brandenberger	1908
● la serranetga/il zip	Martin O. Winterhalter	1923
● il runal	Ernst Gustav Constam	1930
● Nescafé	Max Morgenthaler	1936
● Ricola	Emil Richterich	1940
● Aromat	Walter Obrist	1945
● il spaletschader	Alfred Neweczczal	1947
● il smatga-agl	Karl Zysset	ils onns 1950
● Rivella	Robert Barth	1950
● la serra-sdrap	Georges de Mestral	1951
● il mixer a batgetta	Roger Perrinjaquet	1954
● Swatch (ura)	Nicolas Hayek	1983
● il world wide web	Tim Berners-Lee (CERN Geneva)	1990
● Doodle	Michael Näf e Paul E. Sevinç	2003
● l'aviun solar (Solar Impulse II)	Bertrand Piccard	2015

Invenziun: maschina d'uffants 1

- 1 Tut ils uffants fan in rudè.
- 2 Uffant A va en il rudè e cumenza a far in simpel moviment che sa repeta.
- 3 Uffant B vegn vitiers e fa in auter moviment – sco in nov toc da la maschina.
- 4 Uffant C vegn vitiers e fa puspè in auter moviment da la maschina. Uschia vai vinavant fin che tut ils uffants han «construì» ensemen ina gronda maschina che sa mova permanentamain.

Per variar il tempo ston tuts s'adattar e per exempel far pli spert u pli plaun ils moviments. Vegn l'entira gruppa da far star salda la maschina il medem mument?

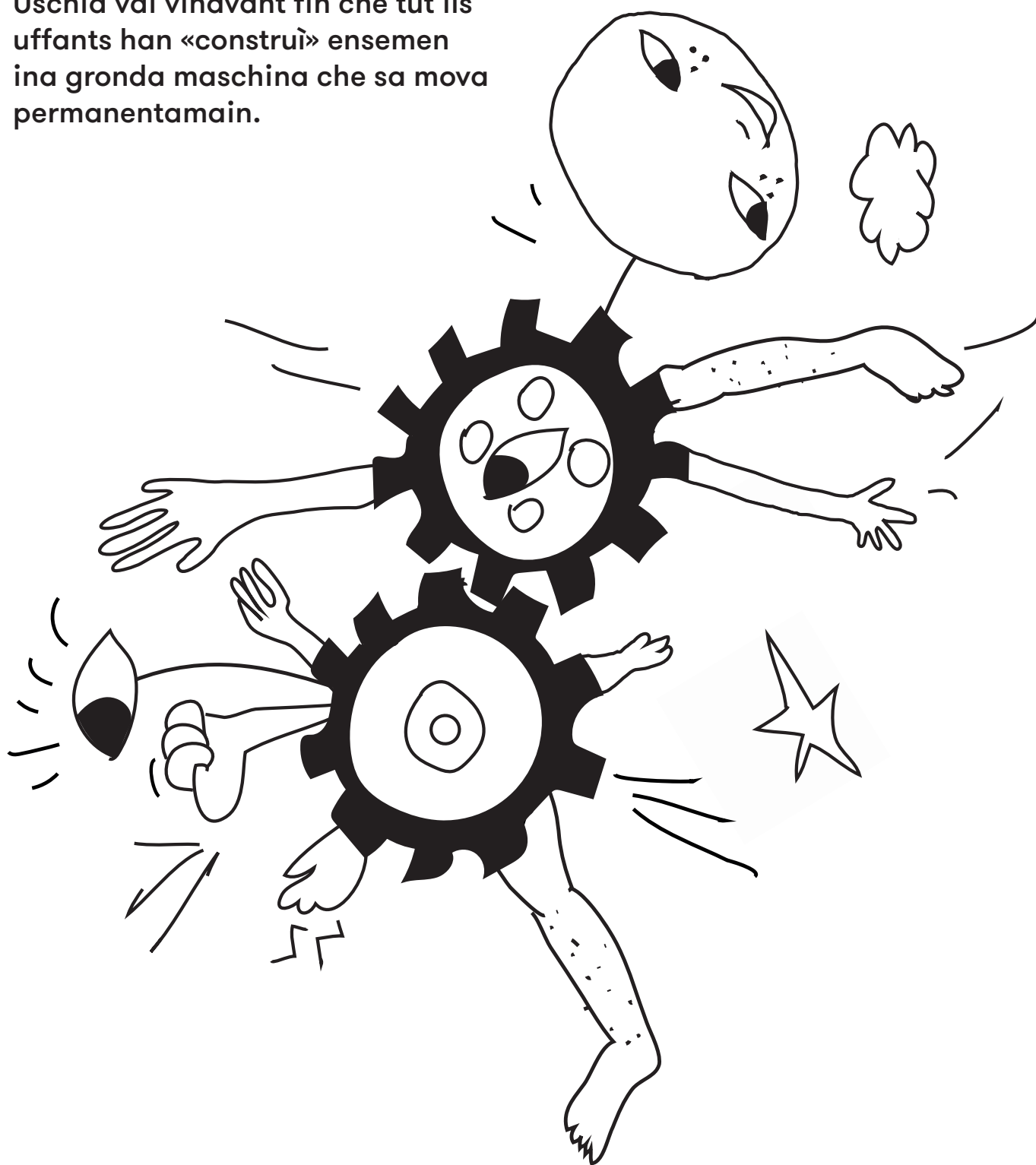

Tia invenziun

2

Tge inventassas ti? Studegia.
Malegia tia invenziun. Co ha tia
invenziun num?



Tes object

3

Rimna palpieri vegl, chartun, buttiglias da PET, stapuns da buttiglias da vin, cuppas, fildarom, etc.

Zambregia cun quest material. Inventa in nov object. Co vesa tia invenziun ora?



Tes pled

Taglia ora plets u era mo parts dals plets e cumbinescha els. Co tuna tes pled inventà?

4

roboter

fifferlotta

tschitschapulvra

frestgera

experiment

tschigulatta

maschine

sapperlot

chaschiel

telefonin

racheta

inventadra

Tes roboter

Taglia ora ils maletgs* e fa ina collascha. Inventa in roboter.
Co vesa el ora e tge sa tes roboter?

* Ils maletgs derivan da: Schnippelbuch Nr. 2,
Kultur & Spielraum e.V. München, 1999/2015,
www.schnippelbuch.de

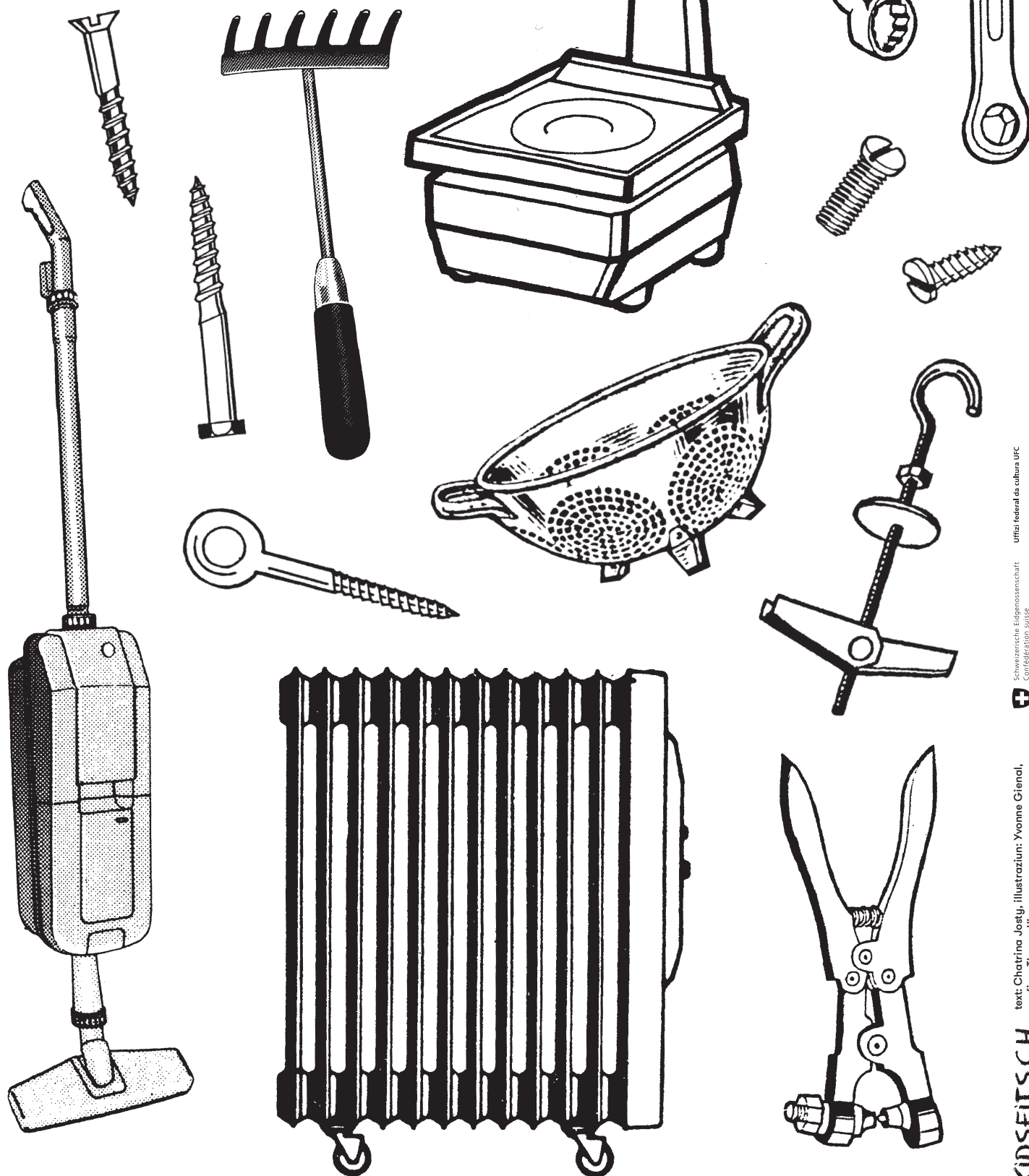

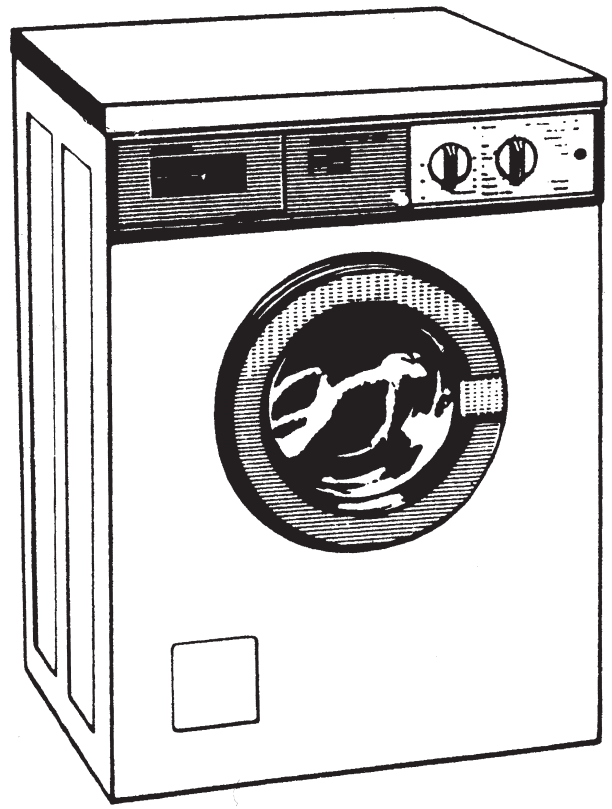
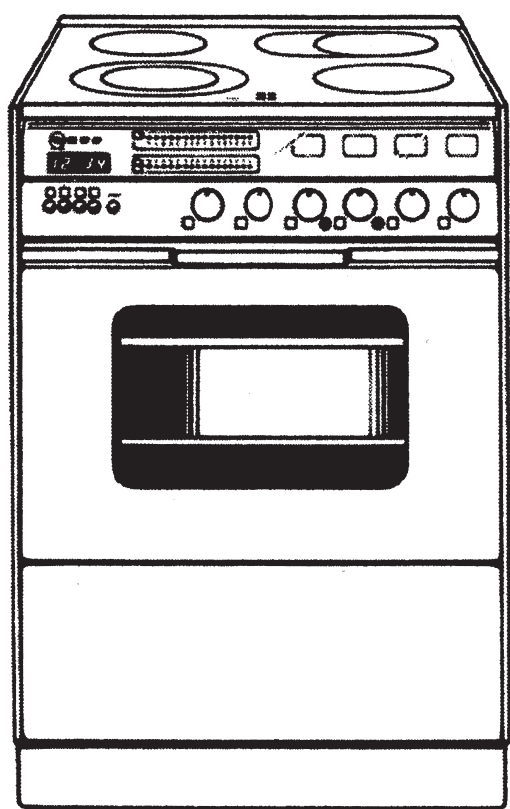
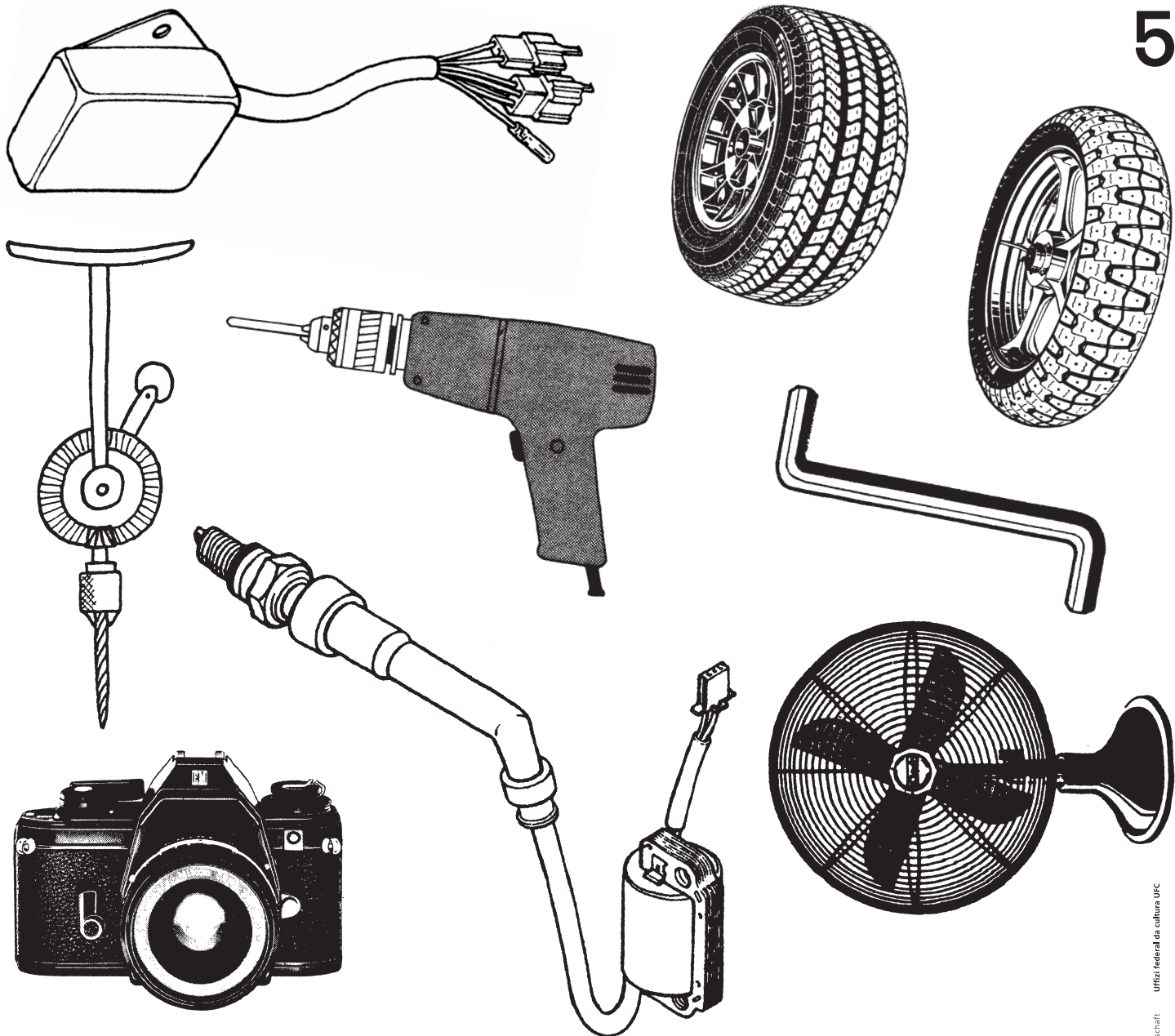

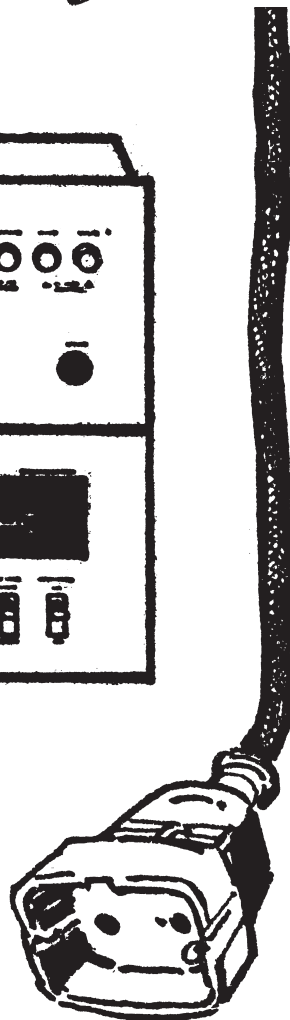
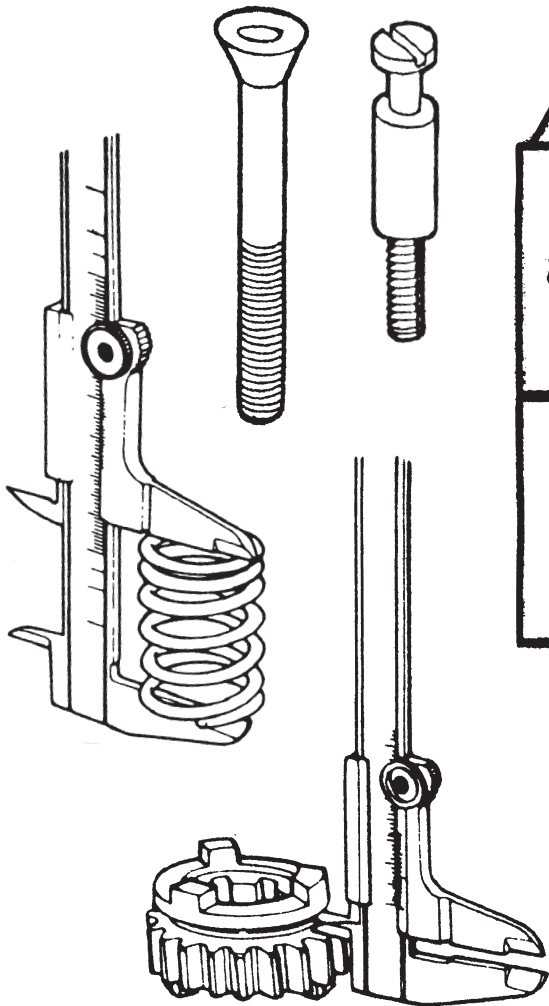
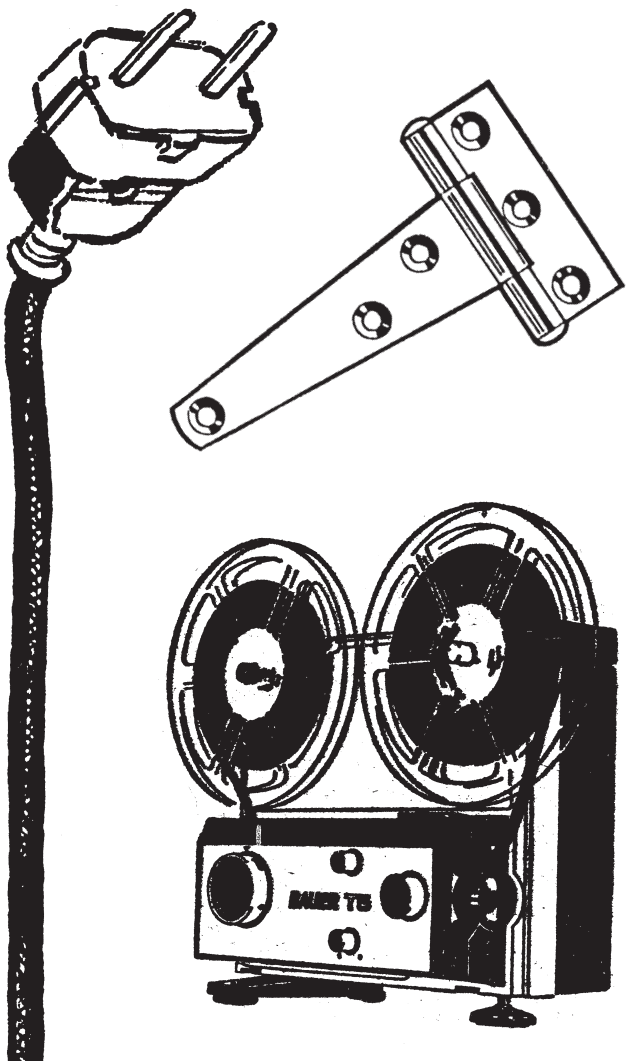
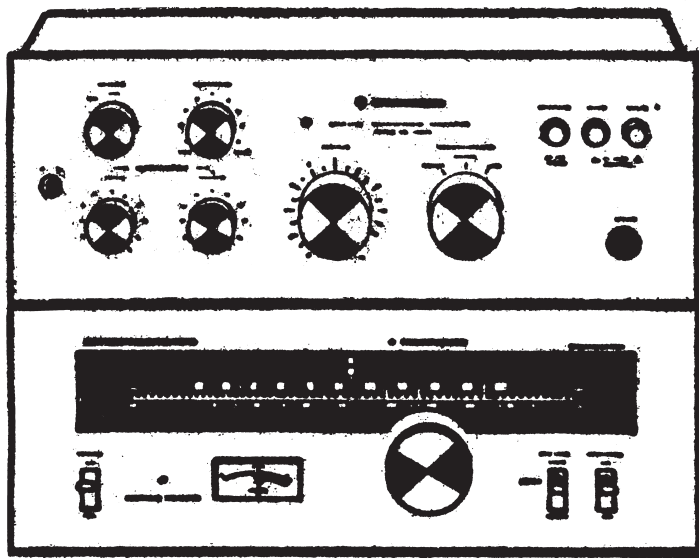
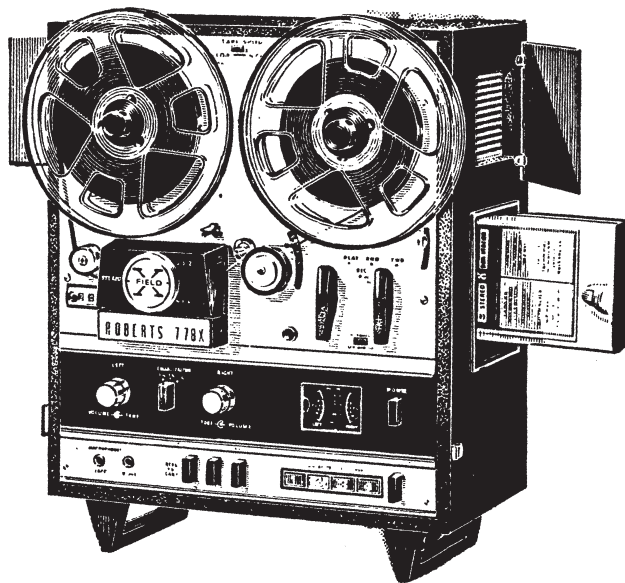
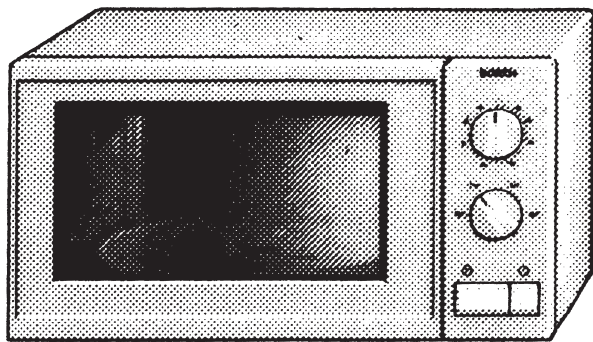

Schweizerische Eidgenossenschaft
Confédération suisse
Confederazione Svizzera
Confederaziun svizra

text: Chattrina Josty, illustraziun: Yvonne Giènal,
grafica: Theres Jönger
© Lia Rumantscha

KIDSFITSCH
Lia Rumantscha



Uffiz federal da cultura UFC