

Oz e igl Gi da las invantadras
a digls invantaders

la roda

igl telefonet

igl trampolin

gl'aviùn

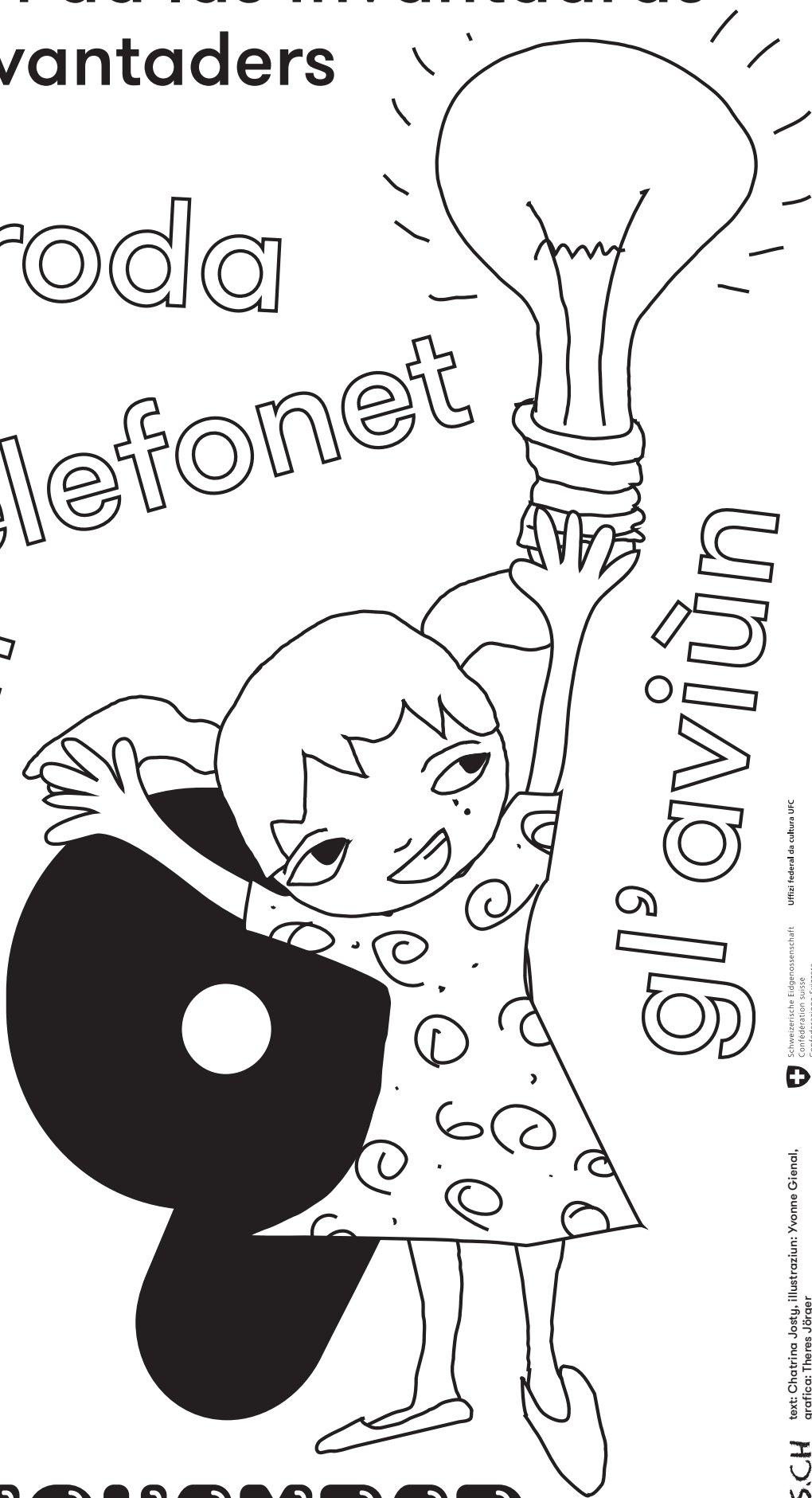

NOVEMBER

Igl Gi da las invantadras a digls invantaders

Tgi â ansasez invanto las tgossas cun nus duvragn mintga gi? Tgi â invanto igl telefonet, igl pér electric, igl velo, la frestgera, igl pulpier near las jeans? Blearas da quellas tgossas en betga stadas qua dad egn gi sen l'oter. Anzatgi â gl'amprem stuieu ver l'ideia a zambargear amprenas versiùns da las tgossas. Quellas parsùnas numn'ign invantadras ad invantaders. Sco par exaimpel igl Thomas Edison c'â fatg experimaints cun forza electrica a c'â gido d'invantar igl pér electric. El â mai do sei! Cur c'el leva invantar anzatge ad igl funcziunava betga imediat, gev'el: «Jou ve mena disgetg, jou ve simplameing cato 10'000 modas co c'igl funcziunescha betga.»

Invantadras ad invantaders en parsùnas cun fantaseia, ideias a curascha. Sco par exaimpel la Hedy Lamarr. Ella eara actura a Hollywood ad invantadra. Gl'on 1941 â ella scho patentar egn'invenziùn da la tecnica da func c'e ple tard davantada la basa pigls noss telefonets ad igl WLAN. La Hedy Lamarr â mena survagnieu raps par la sia invenziùn. Parsuainter e igl sieus gi da naschientscha, igls 9 da november, davanto igl Gi da las invantadras a digls invantaders. Seglmains an la Svizra, l'Austria ad an Tearatudestga. An otras tearas dat igl oters gis da las invantadras a digls invantaders near gis da las invenziùns, mo igl va pigl madem: las invenziùns a la curascha da las invantadras a digls invantaders den inspirar nus tuts. Mintgegn a mintgegna pudess invantar anzatge!

Âs tei ear gea invanto anzatge?
Forza egn gioi near egn tarmagl?

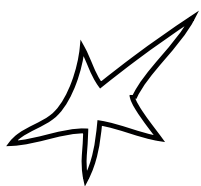

Tge stuess ign tanor te invantar?

Ancanuschas tei invantadras near invantaders?

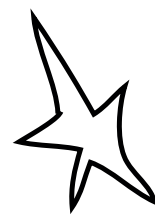

Ampeara agls teas geniturs near a tieus tat a tia tata: Tge invenziùn â mido igl ple fetg lur veta?



Invenziùns interessàntas near/ad impurtàntas

invenziùn	invantader/invantadra	on
● la roda	nunancunaschaint	3'500 a. C.
● igl pulpier	Cai Lun	105 s. C.
● igl velo	Karl Drais	1817
● la maschina da far sglatsch (par magliar)	Nancy Johnson	1843
● igl telefon	Philipp Reiss	1861
● igl schlogn	Thomas Adams	1870
● las jeans	Levi Strauss	1873
● la frestgera	Carl von Linde	1876
● igl pér electric	Thomas Edison	1879
● igl auto	Karl Benz	1885
● Coca-Cola	John Stith Pemberton	1886
● igl tschetgapulver	Hubert Cecil Booth	1901
● igl urset/igl teddy	Richard Steiff	1902
● igl aviùn	frars Wright	1903
● igl jojo	Charles Hettrick	1928
● igl trampolin	George Nissen	1936
● igl amprem computer	Konrad Zuse	1941
● LEGO	Ole Kirk Christiansen	1949
● igl piez par duvrar egn'eada	Marion Donovan	1950
● la zela solara	G. Pearson, D. Chapin, C. Fuller	1954
● igl tschearcel da hula-hoop	Richard Knerr ed Arthur Melin	1958
● igl e-mail	Ray Tomlinson	1971
● igl telefonet	Martin Cooper	1973
● WiFi	Vic Hayes	1997
● igl smartphone	diferaintas firmas, p. ex. Apple	2007

Invenziùns svizras

invenziùn	inventader/inventadra	on
● la Crusch Cotschna	Henry Dunant	1863
● Maggi	Julius Maggi	1886
● la tschiculata da latg	Daniel Peter	1875
● igl cunti da satg	Karl Elsener	1891
● igl aspirin (mied ancùnter igl mal)	Felix Hoffmann	1897
● igl chaschiel Tête de moine	Fritz Bichsel	1899
● igl müesli da Bircher	Maximilian Oskar Bircher-Brenner	anturn igl 1900
● la veia da bob	Caspar Badrutt	1904
● Ovomaltine	Abert Wander	1904
● la folia d'aluminium	Heinrich Alfred Gautschi	1905
● igl cellofan (folia transparenta)	Jacques Edwin Brandenberger	1908
● la searanetga/igl zip	Martin O. Winterhalter	1923
● igl runal	Ernst Gustav Constam	1930
● Nescafé	Max Morgenthaler	1936
● Ricola	Emil Richterich	1940
● Aromat	Walter Obrist	1945
● igl spaletscheader	Alfred Neweczeral	1947
● la pressa d'agl	Karl Zysset	igls ons 1950
● Rivella	Robert Barth	1950
● igl bindel tatgànt	Georges de Mestral	1951
● igl mixer a batgeta	Roger Perrinjaquet	1954
● Swatch (ura)	Nicolas Hayek	1983
● igl world wide web	Tim Berners-Lee (CERN Geneva)	1990
● Doodle	Michael Näf e Paul E. Sevinç	2003
● gl'aviùn solar (Solar Impulse II)	Bertrand Piccard	2015

Invenziùn: maschina d'unfànts 1

- 1 Tut igls unfànts fan egn rudi.
- 2 Igl unfànt A va agl rudi ad antscheva a far egn sempel movimaint ca sarepeta.
- 3 Igl unfànt B vean vetier a fa egn oter movimaint – sco egn nov toc da la maschina.
- 4 Igl unfànt C vean vetier a fa puspe egn oter movimaint da la maschina. Ascheia va'gl anavànt antocen ca tut igls unfànts àn «construieu» anzemel egnà grànda maschina ca samuainta permanentameing.

Par variear igl tempo ston tuts s'adatar a par exaimpel far ple spearat near ple plàn igls movimaints. Riva l'antiera grupa da far star eri la maschina agl madem mumaint?

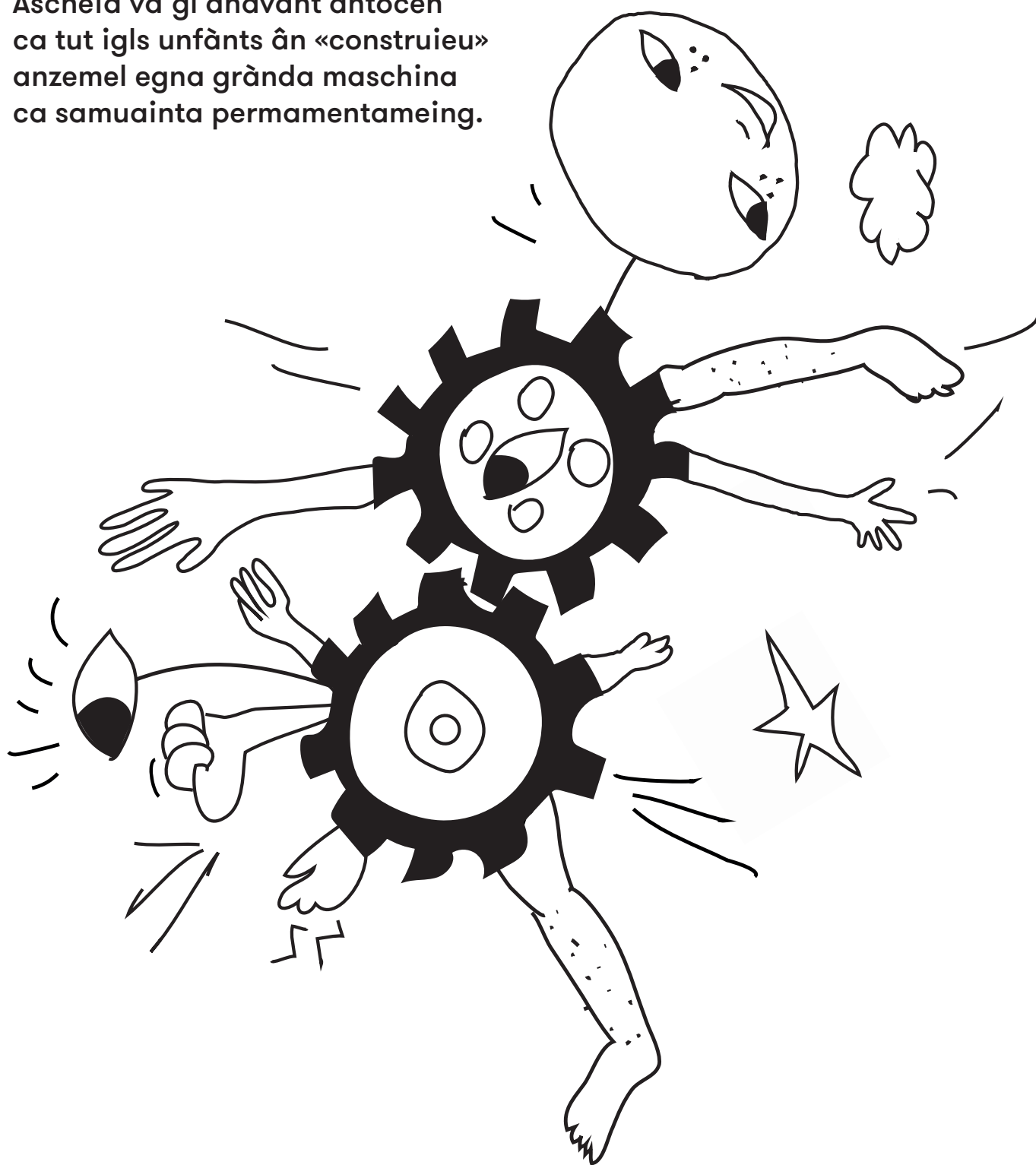

Tia invenziùn

2

Tge invantassas tei? Studegia.
Malegia tia invenziùn. Co â la tia
invenziùn num?



Tieus object

3

Remna pulpier vigl, cartùn, buteglias da PET, stapùns da buteglias da vegn, cupas, fildirom, etc.

Zambregia cun que material. Invariantescha egn nov object. Co veza la tia inveziùn or

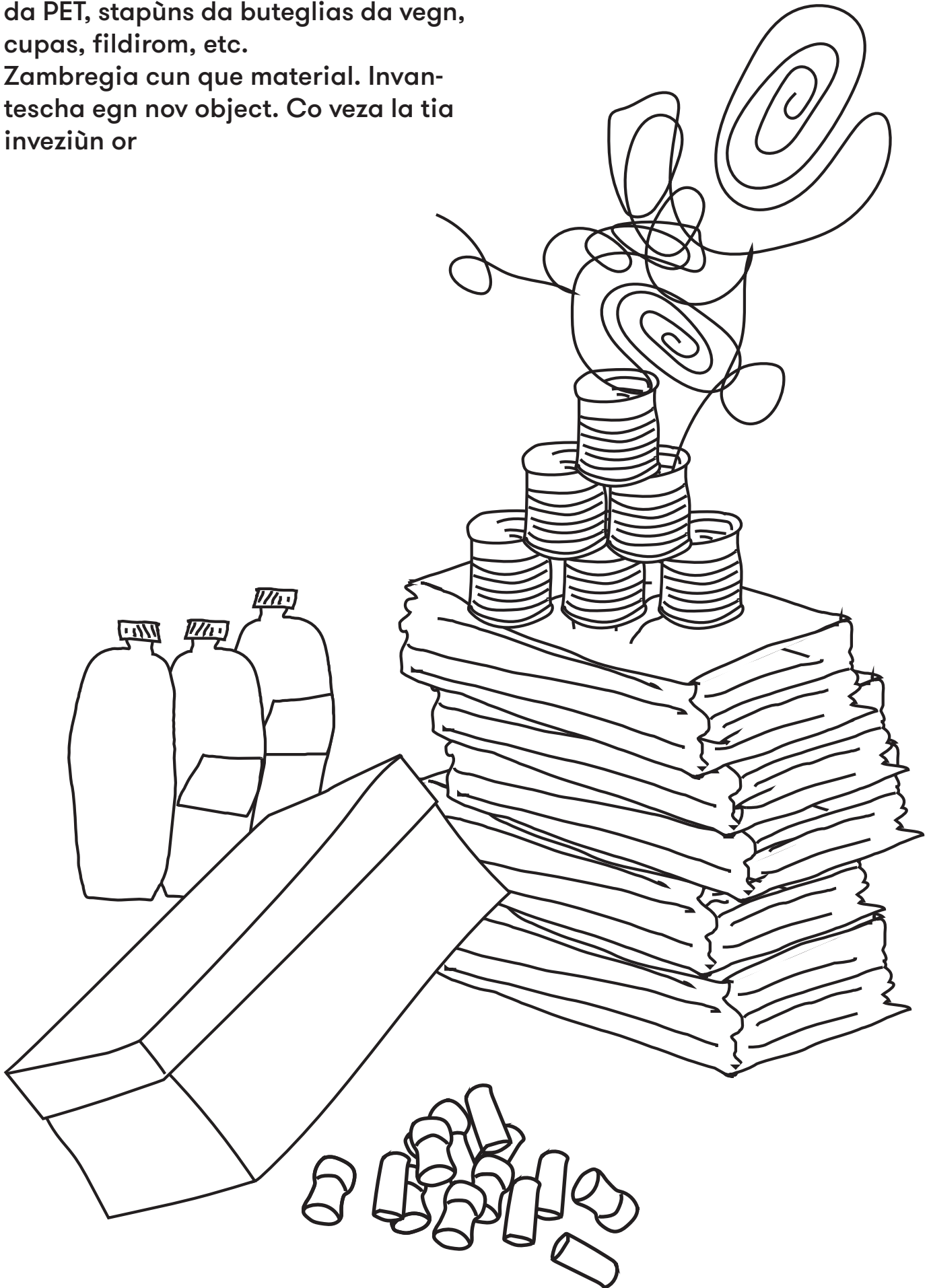

Tieus pled

Taglia or pleds near ear me parts
digls pleds a cumbinescha els.
Co tûna igl tieus pled invanto?

roboter⁴
buaba
tschetgapulver
frestgera
experiment
tschiculata
maschine
sapparlot
caschiel
telefonet
raceta
invantadra

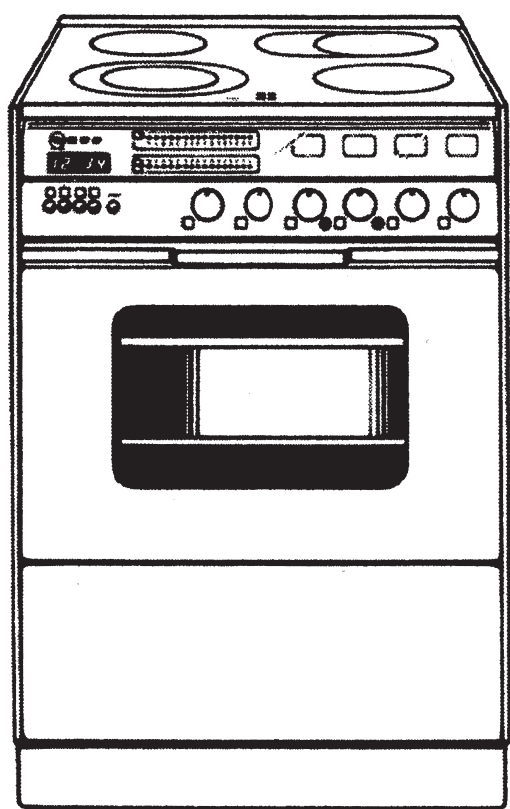
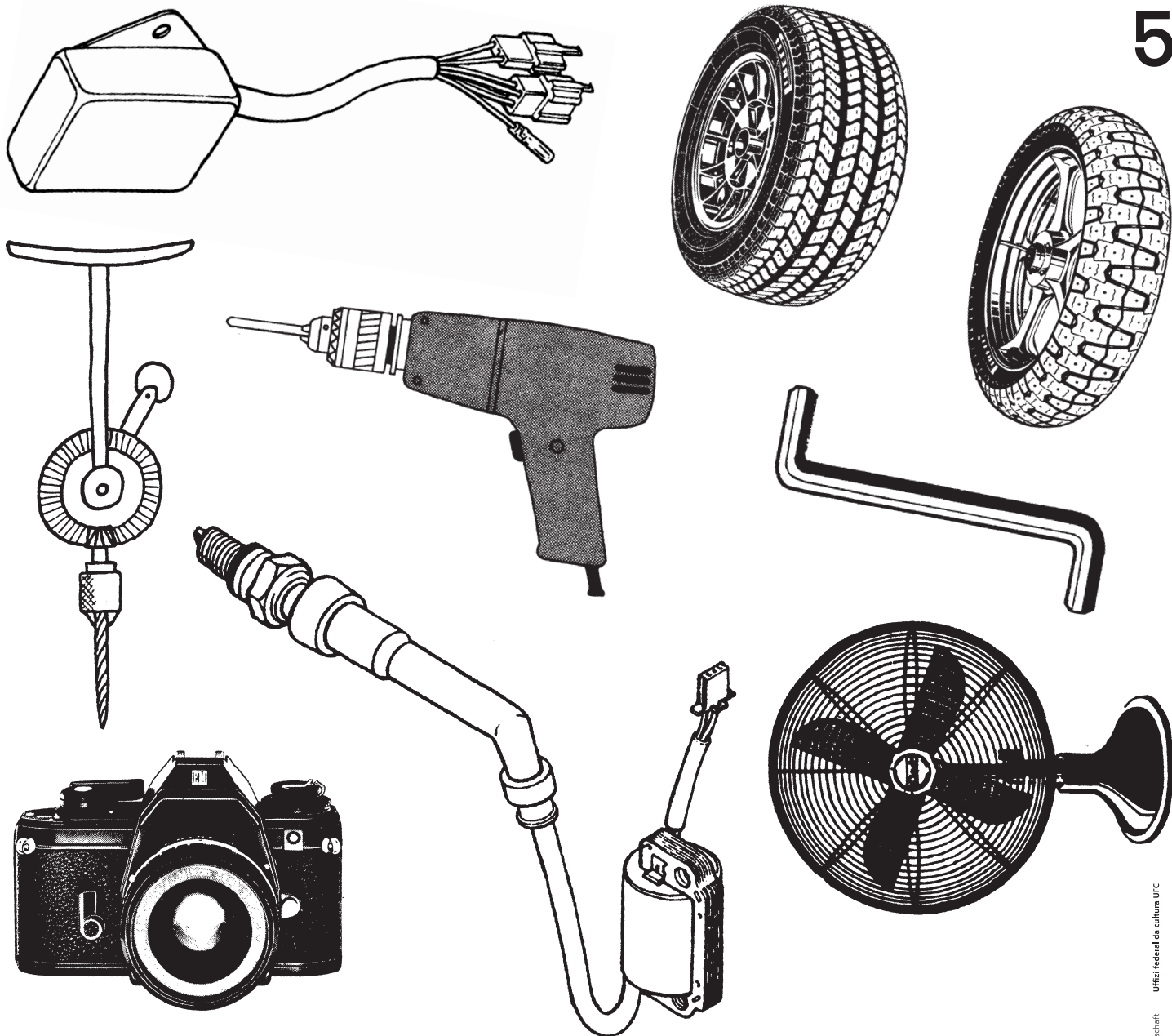

Schweizerische Eidgenossenschaft
 Confédération suisse
 Confederazione Svizzera
 Confederaziun svizra
 Ufficio federal da cultura UFC

text: Chattrina Josty, illustration: Yvonne Gièni,
 grafica: Theres Jäger
 © Lia Rumantscha

KIDSFITTSCH
 Lia Rumantscha

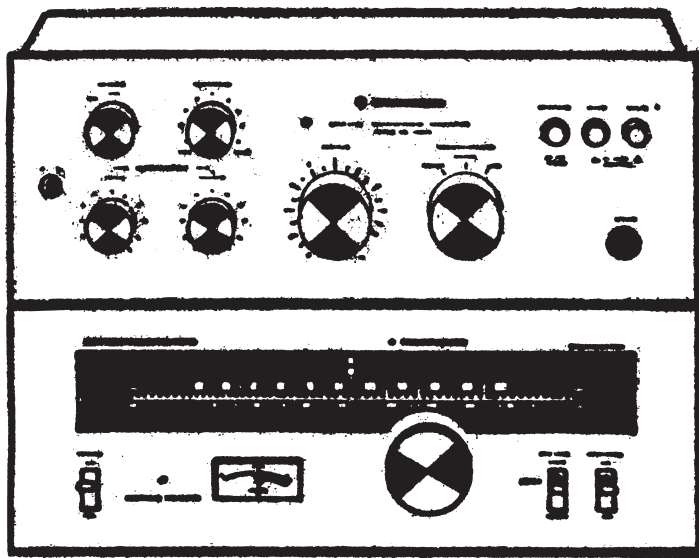
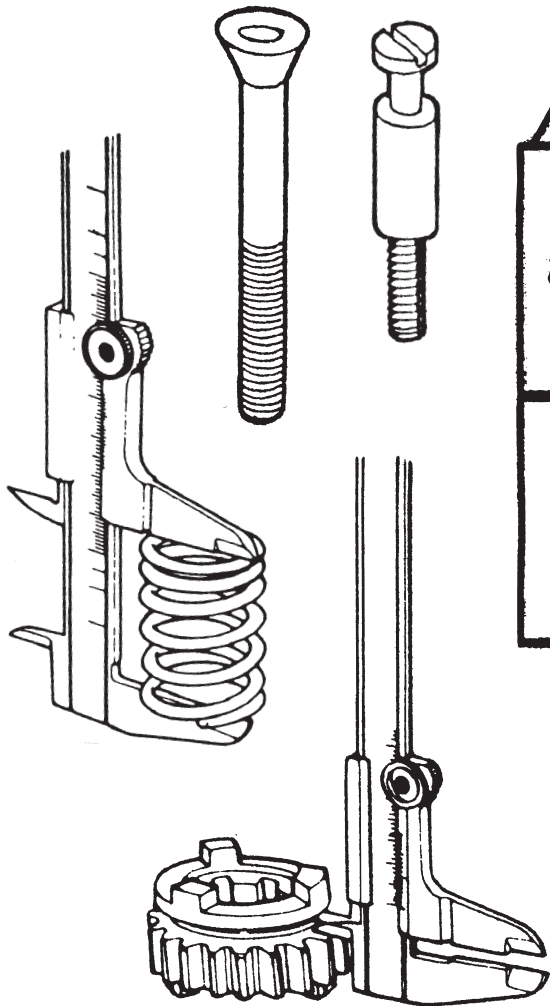
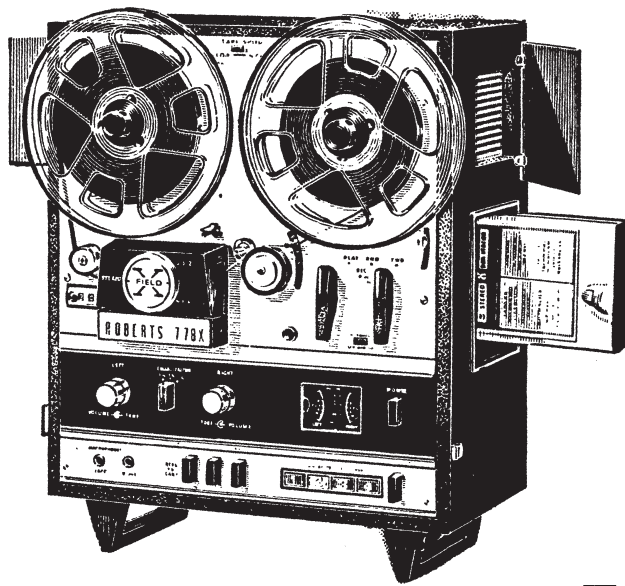
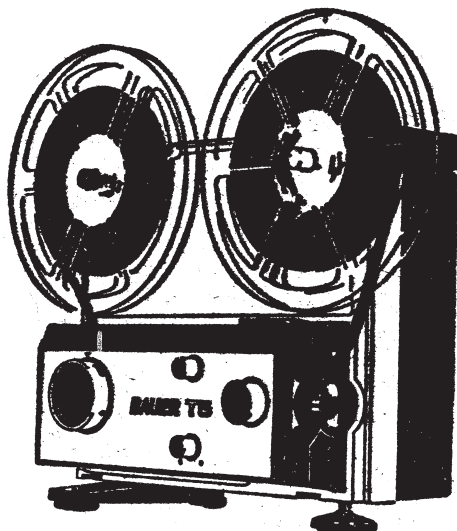
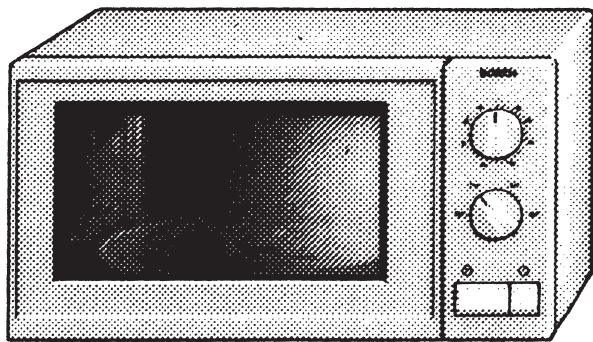
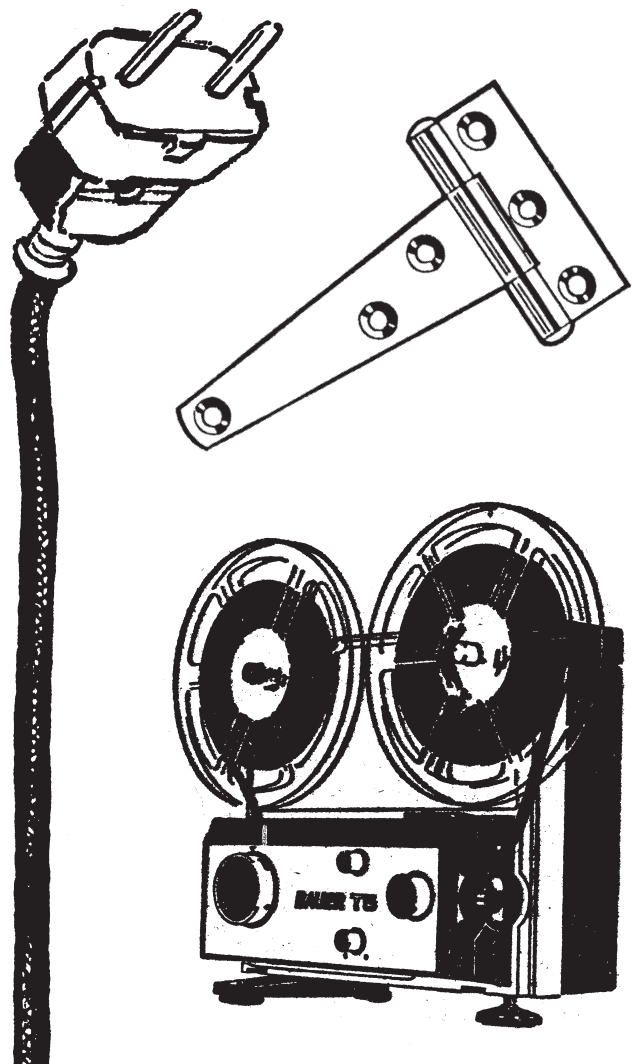

 Schweizerische Eidgenossenschaft
 Confédération suisse
 Confederazione Svizzera
 Confederaziun svizra
 Ufficio federal da cultura UFC

text: Chatrina Josty, Illustration: Yvonne Giènal,
 grafica: Theres Jönger
 © Lia Rumantscha

KIDSFITSCH
 Lia Rumantscha